

SOLISTA LX Ceiling



EN54-23 Fire Alarm Devices
Visual Alarm Device for use in & around buildings

Dispositifs incendie EN54-23
Dispositifs Visuels Alarme Feu pour utilisation
à l'intérieur et autour des bâtiments

EN54-23 Feuermeldevorrichtung
Optischer Signalgeber zur Innen-
und Aussenmontage



DOP No.: 0333-CPD-075443

No.d'identification NF: DL 018 A0

Conforme au référentiel de certification NF-système de sécurité incendie
www.Marque-NF.com

	9-60VDC	
	1.5W (max)	
	3m (max)	
	High Power 1 Hz 0.5Hz	Low Power 1 Hz 0.5Hz
	C-3-7.5 7.5m (132m³)	C-3-5 5m (58.9m³)
	White Flash Flash Blanc Weisser Blitz	12V 51mA 27mA 35mA 19mA 24V 25mA 16mA 16mA 10mA 48V 18mA 11mA 11mA 9mA
	C-3-7.3 7.3m (125m³)	C-3-3 3m (21.2m³)
	Red Flash Flash Rouge Roter Blitz	12V 51mA 27mA 35mA 19mA 24V 25mA 16mA 16mA 10mA 48V 18mA 11mA 11mA 9mA
	< 120% for 10mS	
	100mS ON / 900mS OFF 50mS ON / 950mS OFF	
	0.5mm² - 2.5mm²	
	-25°C ~ 70°C	
	FR ABS & Polycarbonate	
	Type A & B S IP33C	Type B D IP65

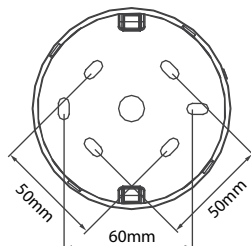
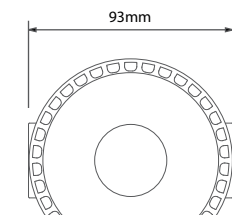

DEEP BASE
Embase Haute
Tiefer Sockel
66mm

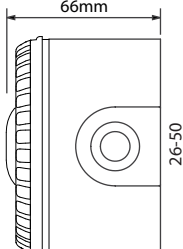

SHALLOW BASE
Embase basse
Flacher Sockel

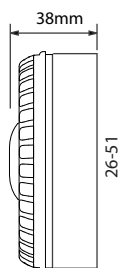

- Screws are not supplied
- Vis non fournies
- Schrauben sind nicht beigelegt

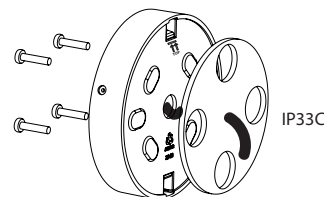

IP33C

- Cable Glands must be compatible with declared cable size.
- Les presses-étoupes doivent être adaptés à la section des câbles déclarée
- Kabeldurchfuehrungen muessen mit den angegebenen Kabelabmessungen kompatibel sein

- Please use a gasket on both sides.
- Un joint torique doit être utilisé de chaque côté.
- An jeder Seite muss ein Dichtungsring angebracht werden.

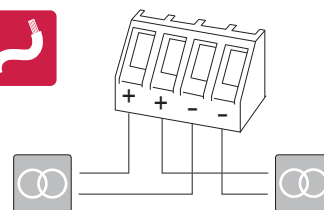
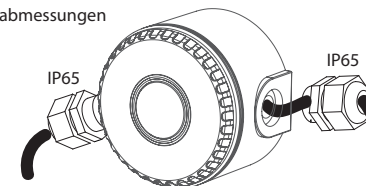
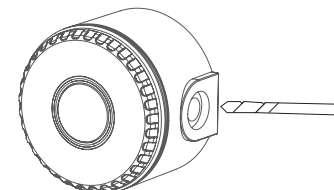

	ON	EN54-23
	1 0	PASS PASS
	1 0	PASS PASS
	0	PASS



Ceiling Mounted: C-3-7.5
Plafonier: C-3-7.5

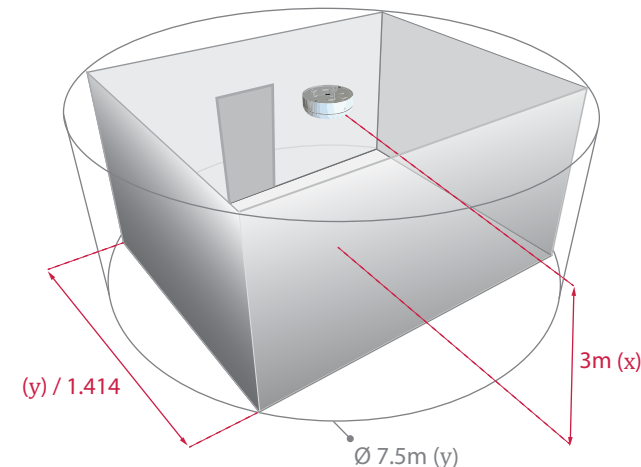

Product Manual M12-005
customerservice@cooperfulleon.com
01633 628566

25-11208-D

Essential Characteristics / Caractéristiques

Operational Reliability / Fiabilité de Fonctionnement	
Duration of operation / Durée de fonctionnement	PASS/CONFORME
Provision for external conductors / Disposition pour conducteurs extérieurs	PASS/CONFORME
Flammability of materials / Inflammabilité des matériaux	PASS/CONFORME
Enclosure protection / Indice de protection	PASS/CONFORME
Access / Accès	PASS/CONFORME
Manufacturer's adjustments / Réglages du fabricant	PASS/CONFORME
On-site adjustment of behaviour / Réglages du site	PASS/CONFORME
Requirements for software controlled devices / Exigences relatives aux dispositifs contrôlés par logiciel	PASS/CONFORME
Performance parameters under fire condition / Paramètres de performance en cas d'incendie	
Coverage Volume / Volume de couverture	PASS/CONFORME
Variation of light output / Variance de la puissance lumineuse	PASS/CONFORME
Minimum/maximum light intensity / Intensité lumineuse minimale/maximale	PASS/CONFORME
Light colour / Couleur de la lumière	WHITE/RED / BLANC/ROUGE
Light pattern & frequency of flashing / Effets temporels lumineux et fréquence de clignotement du flash	0.5/1Hz
Marking & Data / Marquage et données techniques	PASS/CONFORME
Synchronisation	PASS/CONFORME
Temperature Resistance / Résistance à la température	
Dry heat (operational) / Chaleur sèche (fonctionnel)	PASS/CONFORME
Dry heat (endurance) / Chaleur sèche (endurance)	PASS/CONFORME
Cold (operational) / Froid (fonctionnel)	PASS/CONFORME
Humidity Resistance / Résistance à l'humidité	
Damp heat, cyclic (operational) / Chaleur humide, cyclique (fonctionnel)	PASS/CONFORME
Damp heat, steady state (endurance) / Chaleur humide, continue (endurance)	PASS/CONFORME
Damp heat, cyclic (endurance) / Chaleur humide, cyclique (endurance)	PASS/CONFORME
Shock & Vibration & Resistance / Choc & Vibration & Résistance	
Shock (operational) / Choc mécanique (fonctionnel)	PASS/CONFORME
Impact (operational) / Impact (fonctionnel)	PASS/CONFORME
Vibration (operational) / Vibration (fonctionnel)	PASS/CONFORME
Vibration (endurance)	PASS/CONFORME
Corrosion Resistance / Résistance à la corrosion	
SO ₂ corrosion (endurance) / Corrosion par le SO ₂	PASS/CONFORME
Electrical Stability / Stabilité électrique	
EMC immunity (operational) / CEM Immunité (fonctionnel)	PASS/CONFORME



Synchronisation
Synchronisierung

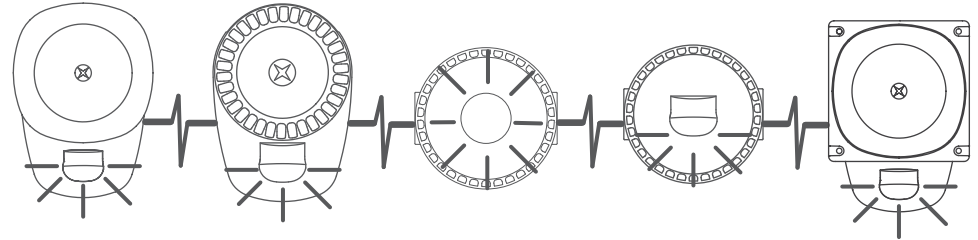

25-11208-D